

Водоравно:

1. $410 + 4 =$

3. $318 + 6 =$

5. $547 + 3 =$

6. $315 + 7 =$

8. $466 + 9 =$

10. $268 + 7 =$

12. $497 + 9 =$

14. $262 + 10 =$

15. $268 + 4 =$

16. $447 + 9 =$

Усправно:

1. $448 + 5 =$

2. $444 + 8 =$

3. $297 + 7 =$

4. $456 + 9 =$

7. $239 + 8 =$

9. $777 + 3 =$

10. $216 + 6 =$

11. $514 + 8 =$

12. $518 + 6 =$

13. $669 + 7 =$

uciteljicajilja.wordpress.com

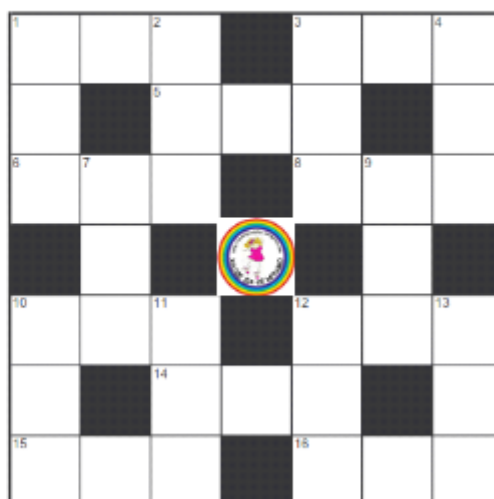

Водоравно:

1. $410 + 4 =$

3. $318 + 6 =$

5. $547 + 3 =$

6. $315 + 7 =$

8. $466 + 9 =$

10. $268 + 7 =$

12. $497 + 9 =$

14. $262 + 10 =$

15. $268 + 4 =$

16. $447 + 9 =$

Усправно:

1. $448 + 5 =$

2. $444 + 8 =$

3. $297 + 7 =$

4. $456 + 9 =$

7. $239 + 8 =$

9. $777 + 3 =$

10. $216 + 6 =$

11. $514 + 8 =$

12. $518 + 6 =$

13. $669 + 7 =$

uciteljicajilja.wordpress.com

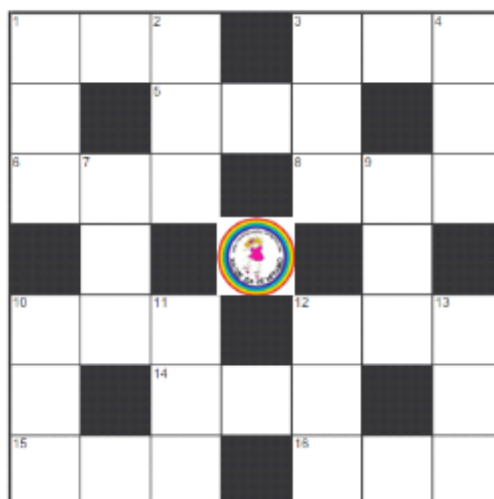

Водоравно:

1. $410 + 4 =$

3. $318 + 6 =$

5. $547 + 3 =$

6. $315 + 7 =$

8. $466 + 9 =$

10. $268 + 7 =$

12. $497 + 9 =$

14. $262 + 10 =$

15. $268 + 4 =$

16. $447 + 9 =$

Усправно:

1. $448 + 5 =$

2. $444 + 8 =$

3. $297 + 7 =$

4. $456 + 9 =$

7. $239 + 8 =$

9. $777 + 3 =$

10. $216 + 6 =$

11. $514 + 8 =$

12. $518 + 6 =$

13. $669 + 7 =$

uciteljicajilja.wordpress.com

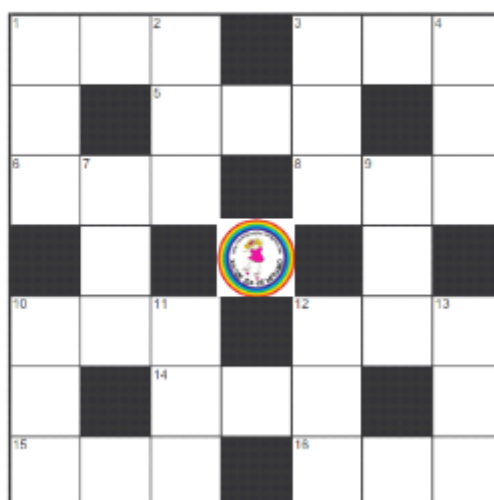

$169 + 8 =$

$678 + 7 =$

$217 + 7 =$

$369 + 7 =$

$424 + 7 =$

$469 + 9 =$

$265 + 6 =$

$729 + 7 =$

$577 + 5 =$

$438 + 5 =$











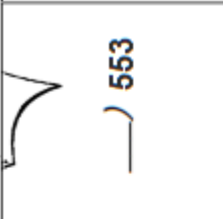



$849 + 9 =$

$679 + 5 =$

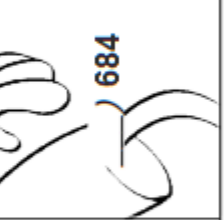
$549 + 4 =$

$975 + 8 =$

$721 + 9 =$

 553	 376	 224	 736	 431
 443	 177	 478	 685	 684
 271	 730	 983	 582	 858

uciteljicaljilja.wordpress.com

$169 + 8 =$

$678 + 7 =$

$217 + 7 =$

$369 + 7 =$

$424 + 7 =$

$469 + 9 =$

$265 + 6 =$

$729 + 7 =$

$577 + 5 =$

$438 + 5 =$











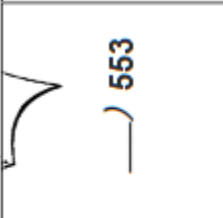



$849 + 9 =$

$679 + 5 =$

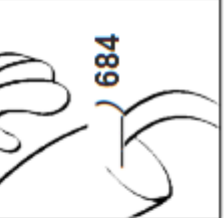
$549 + 4 =$



$975 + 8 =$

$721 + 9 =$

 553	 376	 224	 736	 431
 443	 177	 478	 685	 684
 271	 730	 983	 582	 858

uciteljicaljilja.wordpress.com

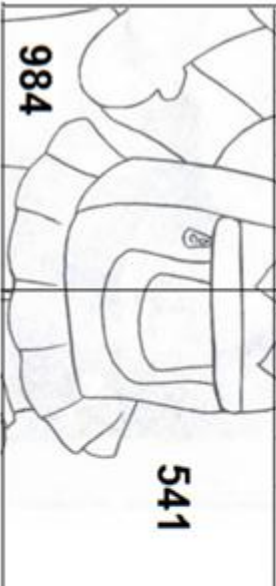
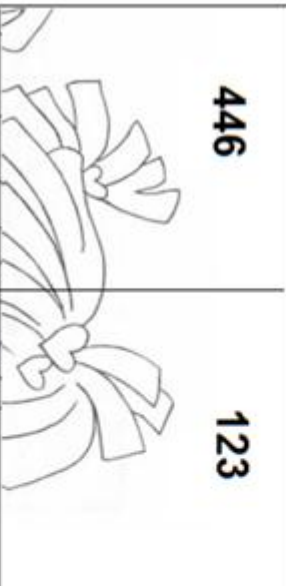
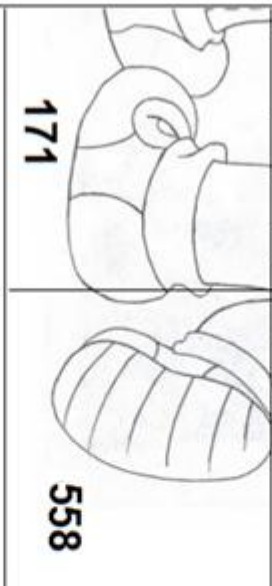
Ovaj zadatak se radi malo drugačije, Deca prvo slože slagalicu, zatim reše zadatke i na kraju pored svakog rešenja upišu na kom se mestu nalazi zadatak sa tim rešenjem.

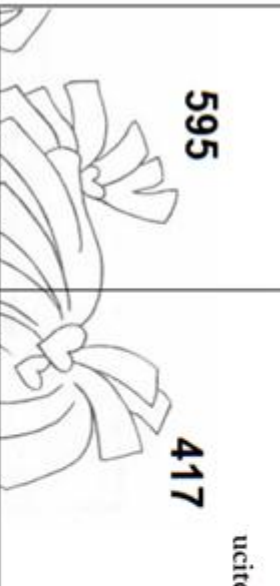
				
984	446	171	611	595
541	123	558	254	417
195	782	155	860	560

uciteljcaljilja.wordpress.com

1. Израчунај:

$425-8=$

$260-6=$

$602-7=$

$620-9=$

$563-3=$

$861-1=$

- За колико је разлика бројева 555 и 8 већа од броја 6?
- Од разлике бројева 1000 и 9 одузми број 7.
- Нађа је купила жваку која кошта 5 динара. Продавцу је дала новчаницу од 200 динара. Колико износи њен кусур?
- У три кутије су кликери у првој кутији је 162 кликера, у другој кутији је 7 кликера мање, а у трећој је 9 кликера више него у првој. Колико је кликера у другој и трећој кутији?
- Мира је имала 560 динара, купила је оловку за 9 динара, а онда је у џепу нашла још 7 динара. Колико новца има Мира сада?

*У овој слагалици има три квадратића вишка, ученици треба да реше задатке, како би узели само делове који припадају тој слагалици

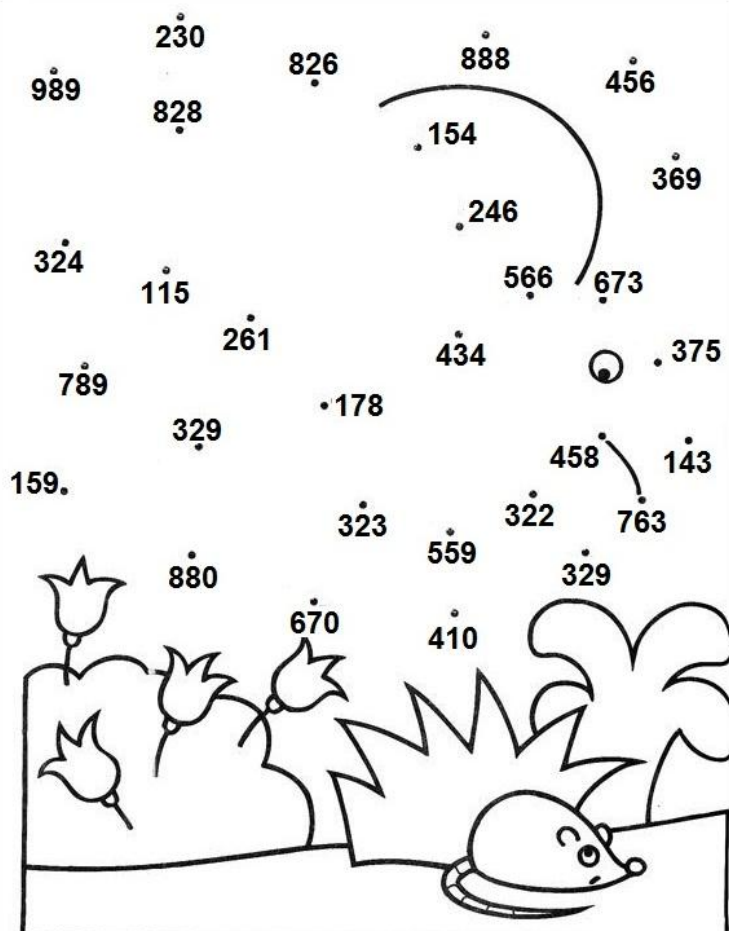

$\begin{array}{r} 454 \\ + 4 \\ \hline \end{array}$	$\begin{array}{r} 329 \\ - 7 \\ \hline \end{array}$	$\begin{array}{r} 556 \\ + 3 \\ \hline \end{array}$	$\begin{array}{r} 328 \\ - 5 \\ \hline \end{array}$
$\begin{array}{r} 663 \\ + 7 \\ \hline \end{array}$	$\begin{array}{r} 885 \\ - 5 \\ \hline \end{array}$	$\begin{array}{r} 162 \\ - 3 \\ \hline \end{array}$	$\begin{array}{r} 333 \\ - 4 \\ \hline \end{array}$
$\begin{array}{r} 169 \\ + 9 \\ \hline \end{array}$	$\begin{array}{r} 253 \\ + 8 \\ \hline \end{array}$	$\begin{array}{r} 123 \\ - 8 \\ \hline \end{array}$	$\begin{array}{r} 333 \\ - 9 \\ \hline \end{array}$
$\begin{array}{r} 835 \\ - 7 \\ \hline \end{array}$	$\begin{array}{r} 832 \\ - 6 \\ \hline \end{array}$	$\begin{array}{r} 145 \\ + 9 \\ \hline \end{array}$	$\begin{array}{r} 238 \\ + 8 \\ \hline \end{array}$
$\begin{array}{r} 442 \\ - 8 \\ \hline \end{array}$	$\begin{array}{r} 557 \\ + 9 \\ \hline \end{array}$	$\begin{array}{r} 664 \\ + 9 \\ \hline \end{array}$	$\begin{array}{r} 367 \\ + 8 \\ \hline \end{array}$
	$\begin{array}{r} 152 \\ - 9 \\ \hline \end{array}$	$\begin{array}{r} 771 \\ - 8 \\ \hline \end{array}$	

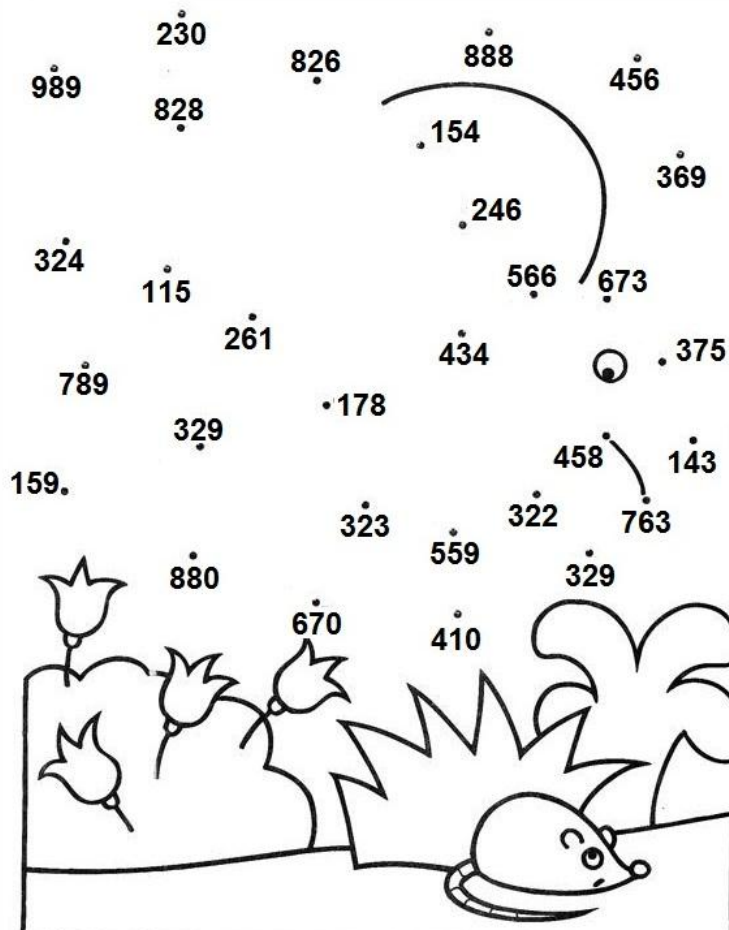

$\begin{array}{r} 454 \\ + 4 \\ \hline \end{array}$	$\begin{array}{r} 329 \\ - 7 \\ \hline \end{array}$	$\begin{array}{r} 556 \\ + 3 \\ \hline \end{array}$	$\begin{array}{r} 328 \\ - 5 \\ \hline \end{array}$
$\begin{array}{r} 663 \\ + 7 \\ \hline \end{array}$	$\begin{array}{r} 885 \\ - 5 \\ \hline \end{array}$	$\begin{array}{r} 162 \\ - 3 \\ \hline \end{array}$	$\begin{array}{r} 333 \\ - 4 \\ \hline \end{array}$
$\begin{array}{r} 169 \\ + 9 \\ \hline \end{array}$	$\begin{array}{r} 253 \\ + 8 \\ \hline \end{array}$	$\begin{array}{r} 123 \\ - 8 \\ \hline \end{array}$	$\begin{array}{r} 333 \\ - 9 \\ \hline \end{array}$
$\begin{array}{r} 835 \\ - 7 \\ \hline \end{array}$	$\begin{array}{r} 832 \\ - 6 \\ \hline \end{array}$	$\begin{array}{r} 145 \\ + 9 \\ \hline \end{array}$	$\begin{array}{r} 238 \\ + 8 \\ \hline \end{array}$
$\begin{array}{r} 442 \\ - 8 \\ \hline \end{array}$	$\begin{array}{r} 557 \\ + 9 \\ \hline \end{array}$	$\begin{array}{r} 664 \\ + 9 \\ \hline \end{array}$	$\begin{array}{r} 367 \\ + 8 \\ \hline \end{array}$
	$\begin{array}{r} 152 \\ - 9 \\ \hline \end{array}$	$\begin{array}{r} 771 \\ - 8 \\ \hline \end{array}$	

Ученици реше први задатак са десне стране, затим пронађу решење са леве стране и даље решавају задатке и повезују тачке које се налазе код решења све док не открију шта се крије на слици.

